

FAST MOVER

Automotive Refinishing

FMT3000

Conventional Suction Spraygun

Product Instruction Manual



PLEASE KEEP THIS MANUAL SAFE FOR FUTURE REFERENCE

T: +44 (0)1582 661993 F: +44 (0)1582 667100 E: sales@fastmovertoolsuk.com

FMT3000
Instruction Manual

IMPORTANT

Please read through this Manual carefully before using the FMT3000.

This tool must only be used for spraying and within the parameters outlined in this manual. All users of the equipment should be trained in any risks associated with the products they are spraying or using as spraying and finishing aids.

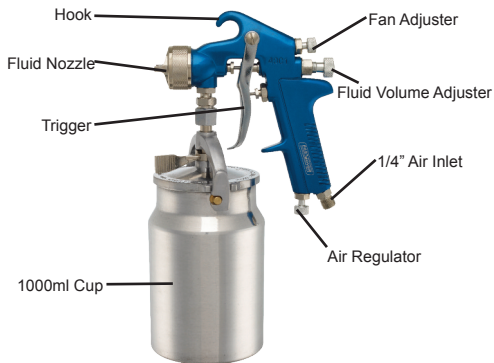

Wise Precaution

This product is free from contaminants. However, we do recommend that you flush your gun through with a suitable thinner before use as a preventative precaution.

Specification

Fluid Tip	1.4, 1.6, 1.8, 2.0 or 2.5mm
Working Pressure	50PSI/3.5BAR
Maximum Pressure	90PSI/6.2BAR
Air Consumption	6.9-8.9CFM
Air Inlet	1/4"
Cup Size	1000ml
Weight	913g

Tool Use

This tool is ideal for primer work and is not suitable for water based paints.

General Safety Instructions

- Users must choose the correct spraygun, with suitable setup and paint flow, for the job requirement.
- Before connecting the spraygun, check the air pressure available is suitable.
- Follow all HSE guidelines regarding sprayguns and their use as well as your own Health & Safety Policy.
- Switch off air source before refilling, cleaning or servicing the spraygun.
- Never leave your spraygun exposed to dust, silicone, acids vapors, explosive or flammable gases, rain, sun, fog or snow.
- Ensure the air line cannot be twisted, pinched or damaged.
- NEVER carry tool by the air hose.
- Never expose air hose to heat, oil, water or sharp edges.
- DO NOT allow children to use or play with this tool or enter the work area.
- DO NOT store this tool in a place that is within reach or accessible to children or unauthorised persons.
- Store this tool in a dry and secure location.
- DO NOT open or tamper with any part of this tool. Cleaning and servicing of the spraygun is permitted but repairs can and must only be carried out by an authorised service centre.

Fast Mover Tools Ltd

T: 01582 661993 F: 01582 667100 E: sales@fastmovertoolsuk.com

W: www.fastmovertoolsuk.com

PLEASE KEEP THIS MANUAL IN A SAFE PLACE FOR FUTURE REFERENCE

- 13 ALWAYS spray in a well ventilated area.
- 14 ALWAYS wear an approved respirator when using this machine.
- 15 DO NOT spray at animals, plants, electrical sources, other persons or their property under any circumstance.
- 16 ALWAYS keep you work area clean and tidy. Untidy work areas are a hazard to yourself and others.
- 17 ALWAYS maintain a stable, secure and comfortable posture when working with this tool. Always avoid stretching and over reaching.
- 18 Avoid using a platform or hop up when using this tool.
- 19 ALWAYS stand on a stable, dry, non-slip surface and wear protective footwear when using this tool.
- 20 Always wear or use the relevant PPE, protective footwear, appropriate gloves, ear defenders, respirator and eye protection must always be worn. Do not wear loose clothing, rings or jewellery and tie long hair back.
- 21 Unauthorised persons and children should not be allowed near the work area or to use the tool and should not be left alone with it.
- 22 All visitors should be made aware of the tool and the hazards relating to it, including but not limited to;
- A: The potentially hazardous nature of the paint material and implications of contact with skin, eyes, clothing and the breathing of vapours.
- B: Trailing air hoses and trip hazards
- C: Slippery surfaces and mess caused by over spray, accidental discharge and spillages.
- D: The risk of accidental discharge.
- E: Avoidance of freshly painted surfaces or workpieces.
- 23 DO NOT hold the workpiece with your hands. Always use clamps or a vice for the best and safest results.
- 24 Ensure that adequate air ventilation and fume extraction is installed in the spraying area if indoors and that it is in good working order.
- 25 If painting outdoors, ensure that over spray is not falling on private property such as cars, bikes, drive ways, windows, etc. and that there is not entry of paint material into watercourses and irrigation ditches.
- 26 Disconnect tool when changing accessories or filling paint cup.
- 27 Switch tool off when moving to a new position.
- 28 Make sure that you have enough slack in the air line to enable unimpeded movement.
- 29 **BE AWARE OF YOUR SURROUNDINGS.** Other persons activities may have potentially lethal implications for you. Likewise, make sure that others around you are aware of your presence and activities and that your own actions are not impeding or harming those around you.
- 30 DO NOT use this tool if parts are missing or damaged. Doing so will invalidate the warranty and may cause yourself or others harm.
- 31 Use only approved service or replacement parts. Not doing so will invalidate the warranty and may cause yourself or others harm.
- 32 DO NOT use incompatible accessories or attachments. Doing so will invalidate the warranty.
- 33 DO NOT attempt to use this tool for any job or purpose outside of its design parameters and capabilities. Doing so will invalidate the warranty.
- 34 Repairs carried out by unauthorised repair agents will invalidate the warranty unless you have been given specific permission by Fast Mover Tools on a case by case basis only.
- 35 Do not use this tools whilst under the influence of drugs, alcohol or intoxicating

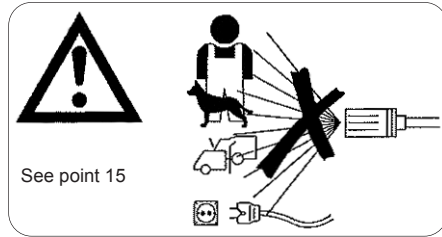

Fast Mover Tools Ltd

Unit 1 Frenchs Avenue, Dunstable, LU6 1BH, United Kingdom

W: www.fastmovertoolsuk.com

FMT3000 Instruction Manual

- medication.
- 36 Do not spray at or near and naked flame or any source of ignition.
- 37 DO NOT spray any material without first consulting a Material Safety Data Sheet. If one is not available it is advised that you source an alternative material.
- 38 Be aware of the dangers of working in or on and building or material containing asbestos. Always take appropriate measures up to an including contracting licensed 3rd parties to remove and/or make safe any asbestos.
- 39 If the material sprayed makes contact with eyes, skin or enters the respiratory system take appropriate measures as advised by the HSE and your own Health and Safety guidelines. If in doubt, seek medical help.
- 40 NEVER point air supply hose at yourself or others.
- 41 Be aware of the dangers and hazards of spraying isocyanate based paints.

Operating Instructions

Preparation

To obtain the best results, it is important that you prepare the surface to be sprayed and thin the paint to the correct viscosity before you start work. Always ensure that the surface to be sprayed is free from dust, dirt, grease and other foreign bodies. Always mask the areas around the areas to be sprayed using good quality masking tape. The paint to be sprayed should be suited to the task and compatible with your spraygun. There should be no lumps or other particles. Make sure that you have a properly working strainer. Many substances can be sprayed with this gun but it is important that you check with your paint supplier before purchasing your paint. It is very important that you check the panel for signs of silicone contamination *before* starting work.

Thinning

Most paints are supplied ready for the type of application and applying technique but may have to be thinned for use with your spraygun. Always follow the paint manufactures advice on thinning paint. A viscosity cup will help you determine the correct viscosity of the paint to be used. To measure the viscosity of the paint fill the cup to the brim and measure the length of time it take to empty. The table below shows the recommended times for different materials. Please note that this is intended as a guide only and you should advice from your paint supplier.

Plastic & Latex	24-28secs	Water based Paint	20-25secs
Primers	24-28secs	Varnishes	20-25secs
Oil based paints	18-22secs	Enamel paints	18-22secs
Aluminium paints	22-25secs	Car underseal	25-35secs
Wood sealers	28-35secs	Wood preservatives	Not required
Wood stains	Not required		

If the paint takes longer than the recommended time to empty, further thinning is required. Mix a small quantity of the appropriate thinner and use the viscosity cup again until the required figure is achieved. Some paints contain lumps and particles and these should be strained before use.

Spraying

Fill the paint cup with the appropriately thinned paint and screw onto the gun. Connect the air hose switch on compressor. See *Fig.1* for the recommended air line setup. It is recommended that you use a test card or scrap panel to make sure that the paint is correct. This also aids comparison with existing paint work.

To get best results, keep your spraygun level and at 90° to the surface at all times (see *Fig.2*). Keep the nozzle 200-300mm from the surface and spray evenly from side to side or up and down. Spraying at an angle will lead to paint runs. Use smooth, even strokes. When spraying large

Fast Mover Tools Ltd

T: 01582 661993 F: 01582 667100 E: sales@fastmovertoolsuk.com

W: www.fastmovertoolsuk.com

PLEASE KEEP THIS MANUAL IN A SAFE PLACE FOR FUTURE REFERENCE

areas, use a criss-cross pattern as shown in Fig. 3.

Never start or stop the gun whilst it is aimed at the workpiece. Too slow a pass will give a thin and patchy coat whilst too fast a pass will result in a heavy coat. Apply one coat at a time and observe manufacturers drying times before applying the next coat or finishing/polishing.

Do not tip the gun more than 45°.

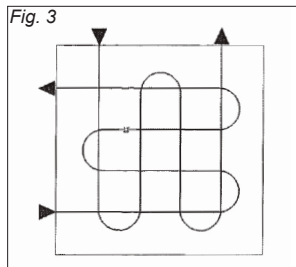
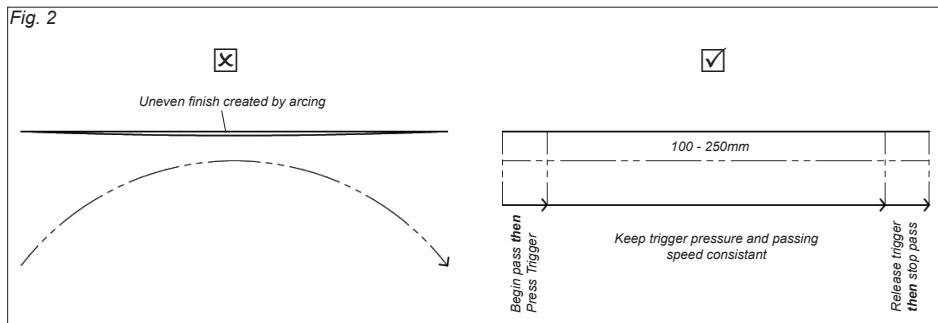
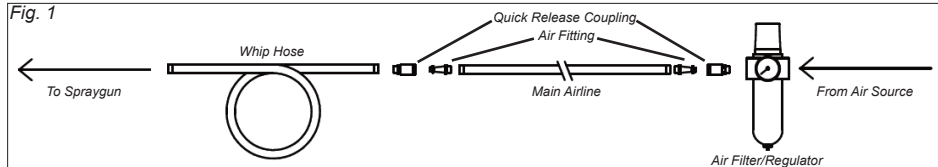



Maintenance

- GUN MUST BE SERVICED BY A COMPETENT PERSON
- ALWAYS DISCONNECT FROM AIR SUPPLY BEFORE CLEANING, DISMANTLING OR SERVICING.
- NEVER IMMERSE GUN IN SOLVENT.
- Pour remaining paint into another container and then clean paint passages and air cap. Spray a small amount of thinner to clean paint passages. Insufficient cleaning adverse pattern shape and particles. Clean promptly two-part paint promptly after use.
- Clean other sections of the gun with the brush soaked in thinner or with a waste cloth.
- Always change to air cap, fluid nozzle and needle as a matched set.
- Lightly lube all moving parts with a non-petroleum based lubricant.

Fast Mover Tools Ltd
 Unit 1 Frenchs Avenue, Dunstable, LU6 1BH, United Kingdom
 W: www.fastmovertoolsuk.com

FMT3000 Instruction Manual

Trouble Shooting

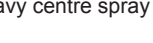
Problem	Cause(s)	Solution(s)
Gun is leaking from fluid nozzle	1 Fluid nozzle loose 2 Foreign particles or dried paint stopping the needle seating.	1 Tighten fluid nozzle 2 Remove and clean nozzle
Gun is leaking from needle sealing area	Teflon packing is damaged or missing	Replace Teflon packing
Paint sputters from gun	1 Not enough materials in cup 2 Material not filtered 3 Fluid nozzle loose 4 Needle packing damaged 5 Needle and nozzle dirty	1 Refill cup 2 Fit filter in cup 3 Tighten 4 Replace packing 5 Clean all components thoroughly
Incorrect atomization	Inlet air pressure too low or material too thick, air pressure too high or material too thin.	Adjust air pressure and/or material viscosity.
Crescent spray pattern 	Paint buildup on air cap partially blocks horn holes, causing air pressure differences	Remove obstructions from horn holes, clean thoroughly
Inclined spray pattern 	1 Paint buildup on air cap partially blocks horn holes or air cap centre hole, or causes damage 2 Loose fluid nozzle	1 Remove obstructions from horn holes, clean thoroughly or replace if damaged 2 Tighten having first cleaned area
Split spray pattern 	1 Paint viscosity too low 2 Fluid output too high	1 Adjust viscosity of paint 2 Adjust fluid or pattern knobs
Heavy centre spray pattern 	1 Paint viscosity too high 2 Fluid output too low	1 Adjust viscosity of paint 2 Increase fluid output

Fast Mover Tools Ltd

T: 01582 661993 F: 01582 667100 E: sales@fastmovertoolsuk.com

W: www.fastmovertoolsuk.com

PLEASE KEEP THIS MANUAL IN A SAFE PLACE FOR FUTURE REFERENCE

Parts Diagram

FMT3000 Conventional Suction Spraygun

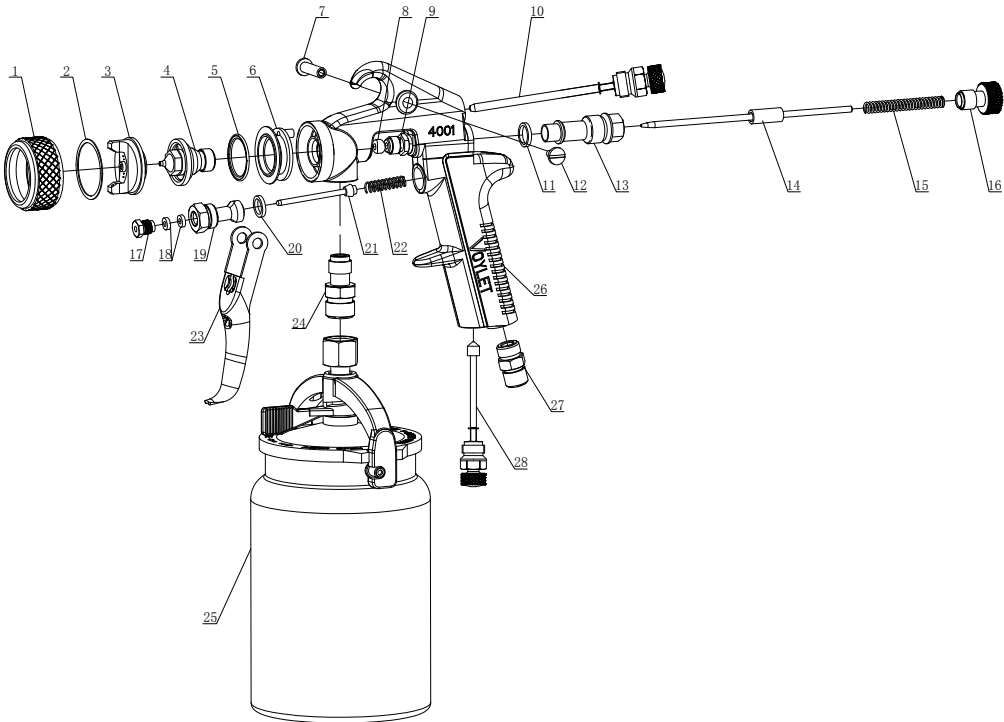

Ref.	Code	Description	Qty
1	FMT3000/1	Air Cap Ring	1
2	FMT3000/2	Gasket	1
3	FMT3000/3	Air Cap	1
4	FMT3000/4	Nozzle	1
5	FMT3000/5	Nozzle Packing Gasket	1
6	FMT3000/6	Baffle	1
7	FMT3000/7	Trigger Stud	1
8	FMT3000/8	Needle Packing	1
9	FMT3000/9	Needle Packing Screw	1
10	FMT3000/10	Pattern Adjustment Screw	1
11	FMT3000/11	Packing Gasket	1
12	FMT3000/12	Bolt	1
13	FMT3000/13	Needle Sleeve	1
14	FMT3000/14	Needle	1
15	FMT3000/15	Spring	1
16	FMT3000/16	Fluid Adjustment Screw	1
17	FMT3000/17	Air Valve Packing Screw	1
18	FMT3000/18	Air Valve Packing	2
19	FMT3000/19	Air Valve Seat	1
20	FMT3000/20	Gasket	1
21	FMT3000/21	Air Valve	1
22	FMT3000/22	Spring	1
23	FMT3000/23	Trigger	1
24	FMT3000/24	Fluid Connector	1
25	FMT3000/25	Paint Cup Assembly	1
26	FMT3000/26	Gun Body	1
27	FMT3000/27	1/4" Air Inlet	1
28	FMT3000/28	Air Adjustment Valve	1



For more information on this or any other product, scan this link.

FMT3000 Instruction Manual

Warranty

We hope that you will be very happy with your purchase. If you do have a problem with your tool, you have the added peace of mind of a 6 month warranty, which comes into date from the date of purchase (proof of purchase required).

Scope of Warranty

- The warranty will cover you from all faults cause by defective components or poor workmanship.
- Tools sent outside the EU are not covered by this warranty.
- Product must be returned to us, the warranty does not cover cost of carriage.
- If the product is no longer in manufacture, it will be replaced with a tool of equivalent or higher specification.

What is not covered

- Normal wear and tear caused by use in accordance with the operating instructions.
- Replacement of any provided accessories, such as Backing Pads, Airline Connections, Air Fittings, Blades, Spanners, etc.
- Accidental damage, faults caused by negligent use or care, neglect, misuse or careless operation, handling and storage of the product.
- Modification of, or change of, any part of this product in any way.
- Faults caused by use of non compatible accessories.
- Tool seizure caused by insufficient oiling.
- Faults caused by incorrect installation.
- Repairs or alterations carried out by non-approved parties.
- Traced of water or rust inside tool - this shows that a properly working air filter has not been used.

Validity

- This warranty is valid for 6 months after date of purchase.
- Warranty is rendered invalid if;
 - Tool is taken apart for any reason without our consent.
 - Tool is not maintained daily.
 - Air supply line is not used with a properly working air filter.



**Please look after the environment, dispose of all packaging in a responsible way.
Always dispose of tools in accordance with local authority guidelines.**

© 2014 Fast Mover Tools Ltd. This document is copyright and is not to be copied, circulated, distributed or shown to anyone other than the intended recipient without the express permission of the directors.

Fast Mover Tools Ltd

T: 01582 661993 F: 01582 667100 E: sales@fastmovertoolsuk.com

W: www.fastmovertoolsuk.com